

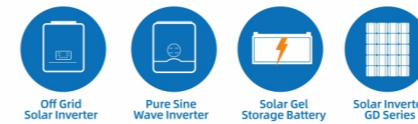

# URAYZERO PRODUCTS CATALOGUE

产品手册



## 雷零科技有限公司

地址：惠州市惠城区水口街道红岭三路40号高盛西湖智谷产业园B2栋1201室  
网站：<https://urayzero.com>  
邮箱：[service@urayzero.com](mailto:service@urayzero.com)

---

## Lei Ling Technology Co., Ltd

Address: 12th Floor, Building B2, GaoSheng West Lake  
Zhigu Industrial Park, No.40, Hongling 3rd Road, Shuikou Street,  
Hui cheng District, Huizhou, Guangdong, China  
WebSite: <https://urayzero.com>  
Email: [service@urayzero.com](mailto:service@urayzero.com)



URAYZERO

# COMPANY PROFILE

雷零科技有限公司成立于中国深圳,工厂设立于惠州市惠城区,是一家专门从事研发、生产和销售新能源产品的科技型企业。产品和服务主要覆盖光伏逆变器、光伏组件、储能电池、及提供整套光储系统解决方案技术支持等;公司自成立以来,专注产品研发、营销布局和客户服务。

一直以来,雷零科技在研发团队强化、产能布局优化、供应链稳定和营销团队全球化等方面持续优化和创新;公司以惠州为中心,在全球建立了广泛的销售渠道,产品已行销至欧洲、亚太、中东和非洲等多个国家。我们致力于为客户提供先进可靠的清洁能源解决方案,以快速响应市场不断变化的需求。

雷零科技坚持以“质量为本、技术创新,服务至上、合作共赢”的核心理念,推动清洁能源全球化发展,为广大客户提供高质量产品和服务。

LeiLing Technology Co., Ltd. was established in Shenzhen city, China which factory is set up in Huicheng, Huizhou. It's a company that specializes in R&D, production, and commercialization of innovative energy products. Its range of offerings encompasses photovoltaic inverters, photovoltaic modules, and energy storage systems, and it provides comprehensive photovoltaic storage solutions along with technical support. Since its inception, the company has been committed to the continuous development and refinement of its product portfolio, marketing layout and customer service.

All along, LeiLing Technology has been continuously optimizing and innovating in the aspects of R&D team strengthening, capacity layout optimization, supply chain stability and marketing team globalization. With Huizhou as the center, the company has established a wide range of sales channels around the world, and its products have been sold to many countries in Europe, Asia Pacific, the Middle East and Africa. We are committed to providing our customers with advanced and reliable clean energy solutions that quickly respond to the changing needs of the market.

LeiLing Technology adheres to the core concept of "quality-oriented, technological innovation, service first, win-win cooperation", promotes the global development of clean energy, and provides high-quality products and services for our customers.

## Enterprise Strength

We have an experienced R&D team and a complete production organizational structure, including R&D department, production department, quality inspecting department and other core departments. The R&D department is responsible for product development and design, the production department is responsible for product manufacturing and assembly, and the quality inspecting department is responsible for product quality control and inspection. Close cooperation between the departments is maintained to ensure the smooth progress of products from R&D to production.

In the future development, we pay more attention to sustainable development, environmental protection, energy conservation and other issues. Through the adoption of eco-friendly technology and energy-saving equipment, we continue to develop eco-friendly products and services to meet consumers' needs for sustainable development.

## Authentication Certificate

ISO9001:2015  
TUV  
MSDS  
CE



## Our Advantages

- Factory direct sale
- OEM orders accepted
- Experienced R&D team
- Ready Stock meet fast delivery
- Professional Online Technical Support
- Excellent sales and after-sale service



# Off Grid Solar Inverter GHL24V3.6KW 离网逆变器

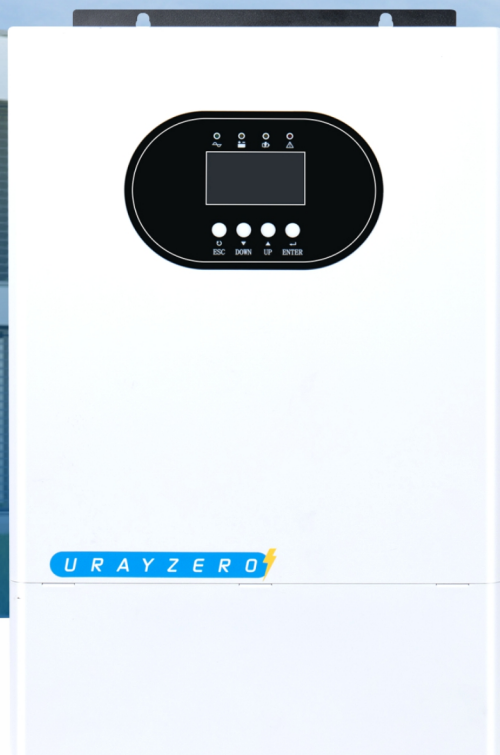

## Features

### 产品亮点:

- 锂电池自动重启功能, 更方便锂电池充电  
Lithium Battery Auto-restart Function, More Convenien for Lithium Battery Charging.
- 通信选项: 外部WiFi, 随时监控  
Communication Option: External WiFi, Supervise at Any Time.
- 市电充电电压/PV充电电压可调, 满足不同的电池充电要求  
Utility Charging Voltage/PV Charging Voltage Adjustable, Match Different Battery Charging Charging Requirements.
- 机身纤薄, 安装运输方便  
Slim Body, Convenient Installation And Transportation.
- PF1.0,高效低耗, 节能/环保/节电/节约成本  
PF1.0,High Efficiency, Lower Consumption, Energy Conservation/ Environmental Protection/Electricity Saving/Cost Saving.
- 高精度输出电压,  $\leq \pm 5\%$ , 爱护您的电器负载  
High Precision of Output Voltage,  $\leq \pm 5\%$ , Take Care of Your Appliances.
- 智能供电模式, 智能分配太阳能电池板/市电电池电量比例  
Intelligent Power Supply Mode, Intelligent Distribution of Solar Panel/Mains Battery Power Shares.
- 支持无电池工作: 降低太阳能系统成本  
Support Working Without Battery: Reduce Solar System Cost.

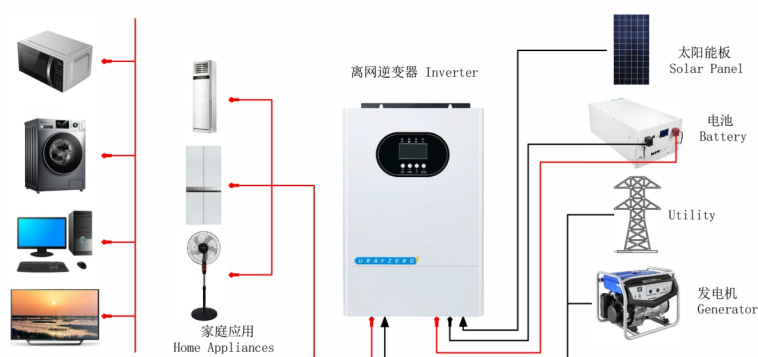

型号 Model		GHL24V3.6KW	
输入 Input	输入源 Input Sources	L+N+PE	
	额定输入电压 Rated Input Voltage	208/220/230/240VAC	
	电压范围 Voltage Range	90~280V 可设置(家用设备/发电机模式)   90~280V Settable(Appliance/Generator mode) 170~264V 可设置(计算机设备模式)   170~264V Settable (UPS mode)	
	频率 Frequency	40~70Hz	
输出 Output	额定负载 Rated Capacity	3600W	
	输出电压 Output Voltage	208/220/230/240VAC	
	输出频率 Output Frequency	市电模式: 跟随市电频率; AG/Grid mode: Synchronized range;   电池模式: 50/60Hz $\pm$ 0.1% Battery Mode: 50/60Hz $\pm$ 0.1%	
	波形 Wave Form	纯正弦波 Pure Sine Wave	
	传输时间 Transfer Time	计算机设备: UPS Mode to Battery Mode 10ms(Typical) 家用电器设备: APP Mode to Battery Mode 10ms(Typical)	
	过载能力 Over Load Ability	Battery Mode: 1min@102%~110% Load ; 10s@110%~130% Load; 3s@130%~150% Load ; 0.2s@>150% Load;	
	峰值效率 (电池模式) Peak Efficiency (Battery Mode)	92.7%@24VDC	
电池 Battery	电池电压 Battery Voltage	24Vdc	
	恒定充电电压(可调) Constant Charging Voltage (adjustable)	28.2Vdc	
	浮动充电电压(可调) Floated Charging Voltage (adjustable)	27Vdc	
充电器 Chargers	光伏最大输入功率 PV MAX Input Power	5000W	
	光伏充电模式 PV Charge Model	MPPT	
	MPPT 跟踪范围 MPPT Tracking Range	40-450Vdc	
	光伏最大输入电压 MAX PV Input Voltage	500Vdc	
	最佳电压 Best Voltage	300-400Vdc	
	最大光伏充电电流 MAX PV Charging Current	100A	
显示屏 Display	液晶显示屏 LCD Display	2 * 8pin/switch 2.54mm,支持128位段码, 最多能支持4个按键+4个LED灯, 可显示运行/输入/输出/负载模式等。 supports 128 bit segment codes, can support up to 4 buttons+4 LED lights, and can display running/input/output/load modes, etc.	
	接口 Interface	Rs232	5PIN/Pitch 2.0mm,Baud Rate 9600
		通讯接口 Communication Port	锂电池BMS通信卡RS485、USB   Lithium battery BMS communication card RS485、USB.
并机功能 Parallel Function		不支持并机 Without Parallel	
环境 Enviornments	操作温度 Operate Temperature	-10-50°C	
	湿度 Humidity	20%~95% (No condensing) 无凝露	
	储存温度 Storage Temperature	-15-60°C	
	海拔 Altitude	海拔高度不应超过 1000m, 1000m 以上降额, 最高4000m, 参考 IEC62040-3; The altitude should not exceed 1000m, and the height above 1000m should lower the loads power, max height of 4000m. Refer to IEC62040-3;	
一般参数 General parameters	防护等级 Protection	IP20	
	产品尺寸 Product size	465*310*115mm	
	包装尺寸 Package size	555*385*208mm	
	净重 Net weight	7.75kg	
	毛重 Gross weight	9kg	



# Off Grid Solar Inverter GHL48V5.5KW/5KW-PLUS 离网逆变器

## Features

### 产品亮点:

- 锂电池自动重启功能, 更方便锂电池充电  
Lithium Battery Auto-restart Function, More Convenient for Lithium Battery Charging.
- 通信选项: 外部WiFi, 随时监控  
Communication Option: External WiFi, Supervise at Any Time.
- 市电充电电压/PV充电电压可调, 满足不同的电池充电要求  
Utility Charging Voltage/PV Charging Voltage Adjustable, Match Different Battery Charging Requirements.
- 机身纤薄, 安装运输方便  
Slim Body, Convenient Installation And Transportation
- PF1.0, 高效低耗, 节能/环保/节电/节约成本  
PF1.0, High Efficiency, Lower Consumption, Energy Conservation/Environmental Protection/Electricity Saving/Cost Saving.
- 支持无电池工作: 降低太阳能系统成本  
Support Working Without Battery: Reduce Solar System Cost.
- GHL48V5KW-PLUS 支持并联功能最多支持9台并机: 扩大更多负载  
Parallel Function Up to Maximum 9 Units: Enlarge Morer Loads.
- 高精度输出电压,  $\leq \pm 5\%$ , 爱护您的电器负载  
High Precision of Output Voltage,  $\leq \pm 5\%$ , Take Care of Your Appliances.
- 智能供电模式, 智能分配太阳能电池板/市电电池电量比例  
Intelligent Power Supply Mode, Intelligent Distribution of Solar Panel/Mains Battery Power Shares.

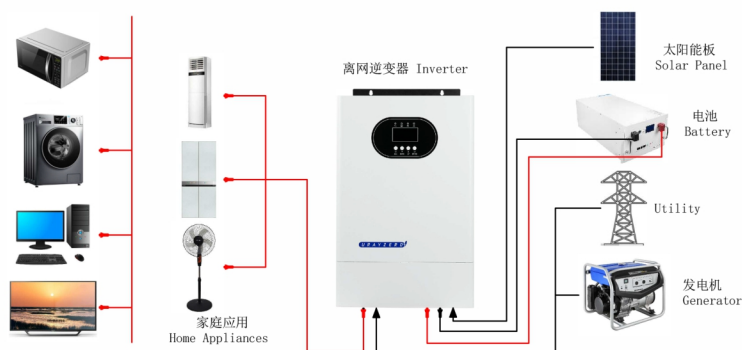

型号 Model		GHL48V5.5KW	GHBL48V5KW-PLUS
输入 Input	输入源 Input Sources	L+N+PE	
	额定输入电压 Rated Input Voltage	208/220/230/240VAC	
	电压范围 Voltage Range	90~280V 可设置(家用设备/发电机模式)   90~280V Settable(Appliance/Generator mode) 170~264V 可设置(计算机设备模式)   170~264V Settable (UPS mode)	
	频率 Frequency	40~70Hz	
输出 Output	额定负载 Rated Capacity	5500W	5000W
	输出电压 Output Voltage	208/220/230/240VAC	
	输出频率 Output Frequency	市电模式: 跟随市电频率; AG/Grid mode: Synchronized range;	电池模式: 50/60Hz $\pm 0.1\%$ Battery Mode: 50/60Hz $\pm 0.1\%$
	波形 Wave Form	纯正弦波 Pure Sine Wave	
	传输时间 Transfer Time	计算机设备: UPS Mode to Battery Mode 10ms(Typical) 家用电器设备: APP Mode to Battery Mode 10ms(Typical)	
	过载能力 Over Load Ability	Battery Mode: 1min@102%~110% Load ; 10s@110%~130% Load; 3s@130%~150% Load ; 0.2s@>150% Load;	
	峰值效率(电池模式) Peak Efficiency (Battery Mode)	94%@48VDC	
电池 Battery	电池电压 Battery Voltage	48Vdc	
	恒定充电电压(可调) Constant Charging Voltage (adjustable)	56.4Vdc	
	浮动充电电压(可调) Floated Charging Voltage (adjustable)	54Vdc	
充电器 Chargers	光伏最大输入功率 PV MAX Input Power	6000W	
	光伏充电模式 PV Charge Model	MPPT	
	MPPT 跟踪范围 MPPT Tracking Range	120-430Vdc	
	光伏最大输入电压 MAX PV Input Voltage	500Vdc	
	最佳电压 Best Voltage	300-400Vdc	
	最大光伏充电电流 MAX PV Charging Current	100A	80A
显示屏 Display	液晶显示屏 LCD Display	2 * 8pin/switch 2.54mm,支持128位段码, 最多能支持4个按键+4个LED灯, 可显示运行/输入/输出/负载模式等。 supports 128 bit segment codes, can support up to 4 buttons+4 LED lights, and can display running/input/output/load modes, etc.	
	接口 Interface	Rs232 5PIN/Pitch 2.0mm,Baud Rate 2400	
	通讯接口 Communication Port	锂电池BMS通信卡RS485、USB Lithium battery BMS communication card RS485、USB.	
环境 Enviornments	并机功能 Parallel Function	不支持并机 Without Parallel	DB9, Parallel board 并机板
	操作温度 Operate Temperature	-10~50°C	
	湿度 Humidity	20%~95% (No condensing) 无凝露	
	储存温度 Storage Temperature	-15~60°C	
一般参数 General parameters	海拔 Altitude	海拔高度不应超过 1000m, 1000m 以上降额, 最高4000m, 参考 IEC62040-3; The altitude should not exceed 1000m, and the height above 1000m should lower the loads power, max height of 4000m. Refer to IEC62040-3;	
	噪音 Noise	$\leq 50$ db	
	防护等级 Protection	IP20	
	产品尺寸 Product size	528*333*132mm	
	包装尺寸 Package size	610*405*200mm	
净重 Net weight	10.20kg		
	毛重 Gross weight	11.65kg	

# Off Grid Solar Inverter GHA48V6.5KW 离网逆变器

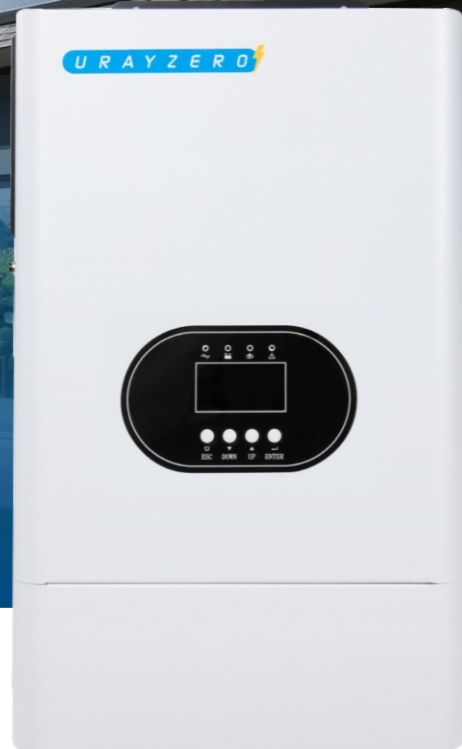

## Features

### 产品亮点:

- 纯正弦波逆变器  
Pure sine wave inverter.
- 支持柴油发电机，双路交流输出  
Support Diesel Generator, Dual AC Output.
- 最高可达120A的最大充/放电电流，最高持续充放电功率可达6.5kW  
UP to 120A Max.Charging/Discharging Current.Up to 6.5kW conti.Charge/Discharge Power.
- 多种工作模式  
Multiple Working Modes.
- 内置WiFi模块  
Built-in WiFi Module.
- 电池平衡功能，延长电池寿命  
Battery Balance Function to Prolong the Battery Life.
- 高精度输出电压， $\leq \pm 5\%$ ，爱护您的电器负载  
High Precision of Output Voltage,  $\leq \pm 5\%$ , Take Care of Your Appliances.

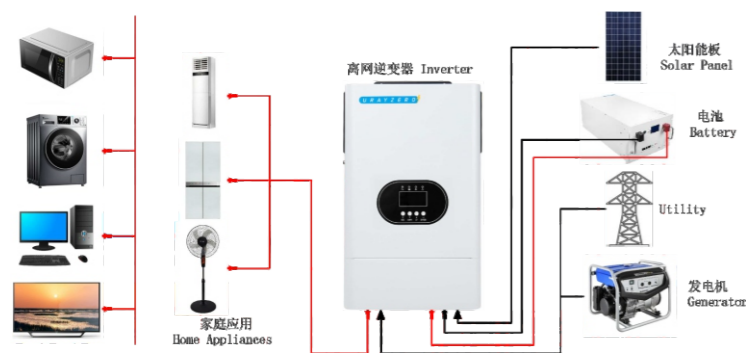

型号 Model		GHA48V6.5KW	
输入 Input	输入源 Input Sources	L+N+PE	
	额定输入电压 Rated Input Voltage	208/220/230/240VAC	
	电压范围 Voltage Range	90~280V 可设置(家用设备/发电机模式)   90~280V Settable(Appliance/Generator mode) 170~280V 可设置(计算机设备模式)   170~280V Settable (UPS mode)	
	频率 Frequency	40~70Hz	
输出 Output	额定负载 Rated Capacity	6500W	
	输出电压 Output Voltage	208/220/230/240VAC	
	输出频率 Output Frequency	市电模式：跟随市电频率； AG/Grid mode: Synchronized range;   电池模式：50/60Hz $\pm$ 0.1% Battery Mode: 50/60Hz $\pm$ 0.1%	
	波形 Wave Form	纯正弦波 Pure Sine Wave	
	传输时间 Transfer Time	计算机设备：UPS Mode to Battery Mode 10ms(Typical) 家用电器设备：APP Mode to Battery Mode 20ms(Typical)	
	过载能力 Over Load Ability	3s@130%-150% load; 10s@110%-130% load	
	峰值效率 (电池模式) Peak Efficiency (Battery Mode)	94%@48VDC	
电池 Battery	电池电压 Battery Voltage	48Vdc	
	恒定充电电压(可调) Constant Charging Voltage (adjustable)	56.4Vdc	
	浮动充电电压(可调) Floated Charging Voltage (adjustable)	54Vdc	
	光伏最大输入功率 PV MAX Input Power	7800W	
充电器 Chargers	光伏充电模式 PV Charge Model	MPPT	
	MPPT 跟踪范围 MPPT Tracking Range	90-500Vdc	
	光伏最大输入电压 MAX PV Input Voltage	550Vdc	
	最佳电压 Best Voltage	300-450Vdc	
	最大光伏充电电流 MAX PV Charging Current	120A	
	最大交流充电电流 MAX AC Charging Current	100A	
显示 Display	液晶显示屏 LCD Display	2 * 8pin/switch 2.54mm,支持128位段码，最多能支持4个按键+4个LED灯，可显示运行/输入/输出/负载模式等。 supports 128 bit segment codes, can support up to 4 buttons+4 LED lights, and can display running/input/output/load modes, etc.	
	接口 Interface	通讯接口 Communication Port	锂电池BMS通信卡RS485、USB。 Lithium battery BMS communication card RS485、USB
		并机功能 Parallel Function	Supports 9 parallel machines
环境 Enviornments	操作温度 Operate Temperature	-10-50°C	
	湿度 Humidity	20%~95% (No condensing) 无凝露	
	储存温度 Storage Temperature	-15-60°C	
	海拔 Altitude	海拔高度不应超过 1000m, 1000m 以上降额, 最高4000m, 参考 IEC62040-3; The altitude should not exceed 1000m, and the height above 1000m should lower the loads power, max height of 4000m. Refer to IEC62040-3;	
一般参数 General parameters	噪音 Noise	$\leq 50$ db	
	防护等级 Protection	IP20	
	产品尺寸 Product size	528*333*132mm	
	包装尺寸 Package size	610*405*200mm	
	净重 Net weight	10.95kg	
毛重 Gross weight	12.05kg		



# Off Grid Solar Inverter GHN48V10.2KW 离网逆变器

## Features

### 产品亮点:

- 纯正弦波太阳能逆变器  
Pure sine wave solar inverter.
- 输出功率因数1.0  
Output power factor 1.0
- WIFI和GPRS可用于IOS和Android  
WIFI&GPRS available for IOS and Android.
- 逆变器可以在无电池的情况下运行  
Inverter can run without battery.
- 一键恢复出厂设置  
One-key restoration to factory Settings.
- 内置锂电池自动激活  
Built-in Lithium battery automatic activation.
- 内置160A MPPT太阳能充电器  
Built-in 160A MPPT solar charger.
- 高光伏输入电压范围 (90-500VDC)  
High PV input voltage range(90-500VDC).
- 内置防尘套件, 适用于恶劣环境  
Built-in anti-dust kit for harsh environment.
- 智能电池充电设计, 优化电池寿命  
Smart battery charge design to optimize battery life.
- 双输出  
Dual output.
- 双光伏输入  
Dual PV input.
- 触摸按钮  
Touch button.
- 离网工作模式  
Off-Grid Work Mode.



型号 Model		GHN48V10.2KW	
输入 Input	输入源 Input Sources	L+N+PE	
	额定输入电压 Rated Input Voltage	208/220/230/240VAC	
	电压范围 Voltage Range	90~280V 可设置(家用设备/发电机模式) 90~280V Settable(Appliance/Generator mode)	170~264V 可设置(计算机设备模式) 170~264V Settable(UPS mode)
	频率 Frequency	50 ~ 60Hz	
输出 Output	额定负载 Rated Capacity	10200W	
	输出电压 Output Voltage	208/220/230/240VAC	
	输出频率 Output Frequency	50/60Hz ± 0.1%	
	波形 Wave Form	纯正弦波 Pure Sine Wave	
	传输时间 Transfer Time	计算机设备: UPS Mode to Battery Mode 10ms(Typical) 家用电器设备: APP Mode to Battery Mode 20ms(Typical)	
电池 Battery	峰值效率 (电池模式) Peak Efficiency (Battery Mode)	> 95%@48VDC	
	电池电压 Battery Voltage	48Vdc	
	恒定充电电压(可调) Constant Charging Voltage (adjustable)	56.4Vdc	
	浮动充电电压(可调) Floated Charging Voltage (adjustable)	54Vdc	
充电器 Chargers	光伏最大输入功率 PV MAX Input Power	2x5400W	
	光伏充电模式 PV Charge Model	双路MPPT Dual MPPT	
	MPPT跟踪范围 MPPT Tracking Range	90-450Vdc	
	光伏最大输入电压 MAX PV Input Voltage	500Vdc	
	最佳电压 Best Voltage	300-400Vdc	
	最大光伏充电电流 MAX PV Charging Current	2x80A	
显示屏 Display	最大交流充电电流 MAX AC Charging Current	140A	
	最大充电电流 MAX Charging Current	160A	
	液晶显示屏 LCD Display	2 * 8pin/switch 2.54mm 可显示运行/输入/输出/负载模式等。 Displayrunning/input/output/load modes, etc.	
接口 Interface	通讯接口 Communication Port	2x5PIN/Pitch2.54mm可扩展RS485、USB Lithium battery BMS communication card RS485、USB,	
	Rs232	5PIN/Pitch 2.0mm,Baud Rate 2400	
环境 Enviornents	操作温度 Operate Temperature	-10~50°C	
	湿度 Humidity	20%~95% (No condensing) 无凝露	
	储存温度 Storage Temperature	-15~60°C	
	海拔 Altitude	海拔高度不应超过 1000m, 1000m 以上降额, 最高4000m, 参考 IEC62040-3; The altitude should not exceed 1000m, and the height above 1000m should lower the loads power, max height of 4000m. Refer to IEC62040-3;	
一般参数 General parameters	噪音 Noise	≤50db	
	防护等级 Protection	IP20	
	产品尺寸 Product size	530*390*130mm	
	包装尺寸 Package size	618*563*205mm	
	净重 Net weight	14.8kg	
毛重 Gross weight	16.2kg		



# Off Grid Solar Inverter GHT48V10.2KW 离网逆变器

## Features

### 产品亮点:

- 纯正弦波太阳能逆变器  
Pure sine wave solar inverter.
- 输出功率因数1.0  
Output power factor 1.0
- WIFI和GPRS可用于IOS和Android  
WIFI&GPRS available for IOS and Android.
- 逆变器可以在无电池的情况下运行  
Inverter can run without battery.
- 一键恢复出厂设置  
One-key restoration to factory Settings.
- 内置锂电池自动激活  
Built-in Lithium battery automatic activation.
- 内置150A MPPT太阳能充电器  
Built-in 150A MPPT solar charger.
- 高光伏输入电压范围 (90-500VDC)  
High PV input voltage range(90-500VDC).
- 智能电池充电设计, 优化电池寿命  
Smart battery charge design to optimize battery life.
- Ac双输出  
Dual AC output.
- 双光伏输入  
Dual PV input.
- 触摸按钮  
Touch button.
- 离网工作模式  
Off-Grid Work Mode.

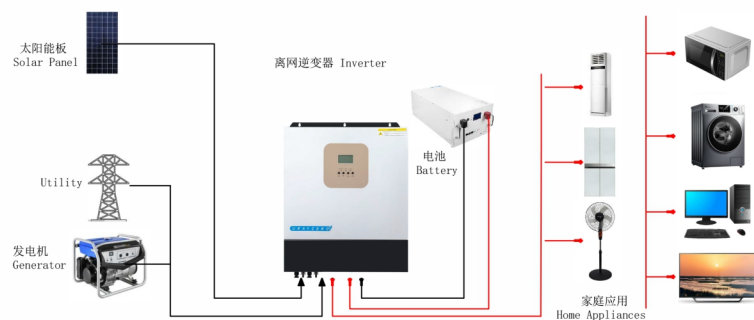

型号 Model		GHT48V10.2KW	
输入 Input	输入源 Input Sources	L+N+PE	
	额定输入电压 Rated Input Voltage	208/220/230/240VAC	
	电压范围 Voltage Range	90~280V 可设置(家用设备/发电机模式) 90~280V Settable(Appliance/Generator mode)	170~264V 可设置(计算机设备模式) 170~264V Settable(UPS mode)
	频率 Frequency	50 ~ 60Hz	
输出 Output	额定负载 Rated Capacity	11000W	
	输出电压 Output Voltage	208/220/230/240VAC	
	输出频率 Output Frequency	50/60Hz ± 0.1%	
	波形 Wave Form	纯正弦波 Pure Sine Wave	
	传输时间 Transfer Time	计算机设备: UPS Mode to Battery Mode 10ms(Typical) 家用电器设备: APP Mode to Battery Mode 20ms(Typical)	
电池 Battery	峰值效率 (电池模式) Peak Efficiency (Battery Mode)	> 98%@48VDC	
	电池电压 Battery Voltage	48Vdc	
	恒定充电电压(可调) Constant Charging Voltage (adjustable)	56.4Vdc	
充电器 Chargers	浮动充电电压(可调) Floated Charging Voltage (adjustable)	54Vdc	
	光伏最大输入功率 PV MAX Input Power	2x5500W	
	光伏充电模式 PV Charge Model	MPPT-48V	
	MPPT 跟踪范围 MPPT Tracking Range	150-500Vdc	
	光伏最大输入电压 MAX PV Input Voltage	500Vdc	
	最佳电压 Best Voltage	300-400Vdc	
	最大光伏充电电流 MAX PV Charging Current	150A	
	最大交流充电电流 MAX AC Charging Current	150A	
显示屏 Display	最大充电电流 MAX Charging Current	150A	
	液晶显示屏 LCD Display	2 * 8pin/switch 2.54mm 可显示运行/输入/输出/负载模式等。 Displayrunning/input/output/load modes, etc.	
接口 Interface	通讯接口 Communication Port	2x5PIN/Pitch2.54mm可扩展RS485、USB Lithium battery BMS communication card RS485、USB、	
	Rs232	5PIN/Pitch 2.0mm,Baud Rate 2400	
环境 Enviornents	操作温度 Operate Temperature	-10~50°C	
	湿度 Humidity	20%~95% (No condensing) 无凝露	
	储存温度 Storage Temperature	-15~60°C	
	海拔 Altitude	海拔高度不应超过 1000m, 1000m 以上降额, 最高4000m, 参考 IEC62040-3; The altitude should not exceed 1000m, and the height above 1000m should lower the loads power, max height of 4000m. Refer to IEC62040-3;	
一般参数 General parameters	防护等级 Protection	IP20	
	产品尺寸 Product size	570.8*500*148.2mm	
	包装尺寸 Package size	708*570*241mm	
	净重 Net weight	19.02kg	
	毛重 Gross weight	22.25kg	

# LWS Series Solar Pumping Inverter

## LWS系列光伏扬水逆变器

(单相 single-phase)  
LWS 1.5kW~2.2kW  
(三相 three-phase)  
LWS 3kW~5kW

(三相 three-phase)  
LWS 7.5kW~11kW

(三相 three-phase)  
LWS 15kW~30kW

(三相 three-phase)  
LWS 37kW~55kW



## Features 产品亮点:

- 专门为光伏水泵设计，适用于多种电机类型；
- Specially designed for photovoltaic water pumps, suitable for various types of motors;
- 可选配市电或柴油发电机作为后备逆变器电源，可满足全天候的用水需求；
- Optional Utility or diesel generators can be used as backup inverter power sources to meet all-weather water demand;
- 智能监控，RS485/GPRS(可选)
- Intelligent monitoring, RS485/GPRS (optional)
- MPPT、正弦波、先进的IGBT功率模块设计，响应速度快，稳定性好；可靠性高，转换效率可达98%；
- MPPT、Sine wave, advanced IGBT power module design, fast response speed, and good stability; High reliability, conversion efficiency can reach 98%;
- 低功率软启动，最大化组件功率利用，全程自动运行。
- Low power soft start, maximizing component power utilization, fully automatic operation throughout the process.
- 防护等级达到IP65;
- The protection level reaches Ip65;

光伏水泵系统结构图  
Structural diagram of photovoltaic water pump system

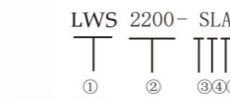
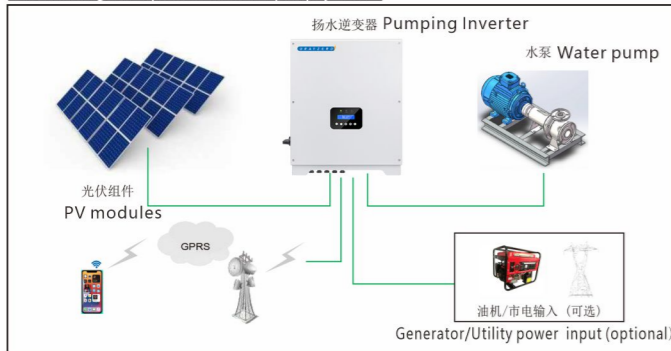

- ①产品系列 Product series
- ②额定输出功率 Rated output power
- ③S- 输出 220V/单相; 无-三相  
S- Output 220V/single-phase; N/A- three-phase
- ④L- 输出 220V/三相; 无-输出 380V/三相  
L- Output 220V/three-phase; N/A- Output 380V three-phase
- ⑤A- 支持交流输入; 无-不支持交流输入  
A- Support AC Input; N/A- Unsupported AC Input

果蔬灌溉 Fruit and vegetable irrigation



荒漠治理 Desert management



畜牧饮水 Livestock drinking water



景点供水 Scenic spot water supply



## LWS系列光伏扬水逆变器技术参数表 Product Parameter

220V输出 (单相) 系列1500W~2200W 220V Output (single-phase) series 1500W~2200W										
型号 Model	最大允许组串数 Maximum allowed string count	启动电压 Starting voltage (Vdc)	最大直流输入电压 Maximum DC input voltage(Vdc)	推荐MPP电压 Recommended MPP voltage(Vdc)	额定输出功率 Rated output power(W)	最大输出电流 Max output current(A)	输出频率 Output frequency (Hz)	防护等级 Protection level	逆变器重量 Inverter weight (Kg)	包装尺寸 packing size(mm) 长宽高 length width height
LWS 1500-SL	1	80	500	200~400	1500	10	0~50/60	IP65	10	495 420 245
LWS 1500-SLA	1	80	500	200~400	1500	10	0~50/60	Ip65	10	495 420 245
LWS 2200-SL	1	80	500	270~400	2200	14	0~50/60	Ip65	10	495 420 245
LWS 2200-SLA	1	80	500	270~400	2200	14	0~50/60	Ip65	10	495 420 245

220V输出 (三相) 系列1500W~2200W 220V Output (three-phase) series 1500w~2200W										
型号 Model	最大允许组串数 Maximum allowed string count	启动电压 Starting voltage (Vdc)	最大直流输入电压 Maximum DC input voltage(Vdc)	推荐MPP电压 Recommended MPP voltage(Vdc)	额定输出功率 Rated output power(W)	最大输出电流 Max output current(A)	输出频率 Output frequency (Hz)	防护等级 Protection level	逆变器重量 Inverter weight (Kg)	包装尺寸 packing size(mm) 长宽高 length width height
LWS 1500-L	1	80	450	200~360	1500	7	0~50/60	IP65	10	495 420 245
LWS 1500-LA	1	80	450	200~360	1500	7	0~50/60	IP65	10	495 420 245
LWS 2200-L	1	80	450	270~360	2200	11	0~50/60	IP65	10	495 420 245
LWS 2200-LA	1	80	450	270~360	2200	11	0~50/60	IP65	10	495 420 245

三相380V输出系列3000W~22kW Three-phase 380V output series 3000w~22kW										
型号 Model	最大允许组串数 Maximum allowed string count	启动电压 Starting voltage (Vdc)	最大直流输入电压 Maximum DC input voltage(Vdc)	推荐MPP电压 Recommended MPP voltage(Vdc)	额定输出功率 Rated output power(W)	最大输出电流 Max output current(A)	输出频率 Output frequency (Hz)	防护等级 Protection level	逆变器重量 Inverter weight (Kg)	包装尺寸 packing size(mm) 长宽高 length width height
LWS 3000	2	250	900	450~750	3000	8	0~50/60	IP65	11	495 495 245
LWS 3000-A	2	250	900	450~750	3000	8	0~50/60	IP65	11.5	495 495 245
LWS 4000	2	250	900	450~750	4000	10	0~50/60	IP65	11	495 495 245
LWS 4000-A	2	250	900	450~750	4000	10	0~50/60	IP65	11.5	495 495 245
LWS 5500	2	250	900	450~750	5500	11	0~50/60	IP65	11	495 495 245
LWS 5500-A	2	250	900	450~750	5500	11	0~50/60	IP65	11.5	495 495 245
LWS 7500	3	250	900	450~750	7500	18	0~50/60	IP65	13	567 440 250
LWS 7500-A	3	250	900	450~750	7500	18	0~50/60	IP65	14	567 440 250
LWS 9200	3	250	900	450~750	9200	21	0~50/60	IP65	13	567 440 250
LWS 9200-A	3	250	900	450~750	9200	21	0~50/60	IP65	14	567 440 250
LWS 11K	3	250	900	450~750	11000	24	0~50/60	IP65	13	567 440 250
LWS 11K-A	3	250	900	450~750	11000	24	0~50/60	IP65	14	567 440 250
LWS 13K	4	250	900	450~750	13000	28	0~50/60	IP65	19	586 512 280
LWS 13K-A	4	250	900	450~750	13000	28	0~50/60	IP65	20	586 512 280
LWS 15K	4	250	900	450~750	15000	30	0~50/60	IP65	19.5	586 512 280
LWS 15K-A	4	250	900	450~750	15000	30	0~50/60	IP65	20.5	586 512 280
LWS 18K5	6	250	900	450~750	18500	39	0~50/60	IP65	21	586 512 280
LWS 18K5-A	6	250	900	450~750	18500	39	0~50/60	IP65	22	586 512 280
LWS 22K	6	250	900	450~750	22000	45	0~50/60	IP65	21	586 512 280
LWS 22K-A	6	250	900	450~750	22000	45	0~50/60	IP65	22	586 512 280

三相380V输出系列26kW~55kW Three-phase 380V output series 3000w~22kW										
型号 Model	最大允许组串数 Maximum allowed string count	启动电压 Starting voltage (Vdc)	最大直流输入电压 Maximum DC input voltage(Vdc)	推荐MPP电压 Recommended MPP voltage(Vdc)	额定输出功率 Rated output power(W)	最大输出电流 Max output current(A)	输出频率 Output frequency (Hz)	防护等级 Protection level	逆变器重量 Inverter weight (Kg)	包装尺寸 packing size(mm) 长宽高 length width height
LWS 26K	6	250	900	450~750	26000	50	0~50/60	IP65	21	586 512 280
LWS 26K-A	6	250	900	450~750	26000	50	0~50/60	IP65	22	586 512 280
LWS 30K	6	250	900	450~750	30000	60	0~50/60	IP65	21	586 512 280
LWS 30K-A	6	250	900	450~750	30000	60	0~50/60	IP65	22	586 512 280
LWS 37K	8	250	900	450~750	37000	75	0~50/60	IP65	30	750 530 315
LWS 37K-A	8	250	900	450~750	37000	75	0~50/60	IP65	32	750 530 315
LWS 45K	8	250	900	450~750	45000	91	0~50/60	IP65	30	750 530 315
LWS 45K-A	8	250	900	450~750	45000	91	0~50/60	IP65	32	750 530 315
LWS 55K	8	250	900	450~750	55000	112	0~50/60	IP65	30	750 530 315
LWS 55K-A	8	250	900	450~750	55000	112	0~50/60	IP65	32	750 530 315



# LiFePO<sub>4</sub> Battery

## 51.2V-5.12kWh-01/06

### 磷酸铁锂电池



## Features

### 产品亮点:

- 内置智能BMS保护模块  
Built in Intelligent BMS Protection Module.
- 循环寿命不低于6000次（使用条件80%放电深度，0.5C放电倍率）  
≥6000Cycle@80%DOD@0.5C Discharge Rate.
- 采用方形铝壳电芯，安全性能更高  
Adopting prismatic aluminum shell cells for higher safety performance.
- 采用模块化设计，可支持16台并联  
Adopting modular design, it can support 16 parallel devices.
- 两侧设有提手，方便搬运  
There are handles on both sides for easy transportation.
- 防护等级IP20，适合室内使用  
Protection level IP20, suitable for indoor use.
- 支持主流逆变器CAN&RS485通讯  
Support mainstream Inverter CAN&RS485 Communication.
- 通过LCD显示屏可进行本地监控  
Local Monitoring can be Achieved Through LCD Display Screen.

## Product Parameter

型号 Model		51.2V-5.12kWh-01	51.2V-5.12kWh-06
电学特性 Electrical Characteristics	电芯材料 Battery Cell Material	磷酸铁锂 Lithium Iron Phosphate (LiFePO <sub>4</sub> )	
	标称电压 Nominal Voltage	51.2V	
	标称容量 Nominal Capacity	100Ah	
	标称电量 Nominal Energy	5.12kWh	
	输出功率 Output Power	5.12kW	
	充电上限电压 Upper charge voltage:	55.2V	
	放电截止电压 Discharge cut-off voltage	44.8V	
	自放电率 Self-Discharge Rate	< 2%每月 < 2%Per Month	
寿命 Lifespan	≥6000Cycle@80%放电深度@0.5C放电倍率 ≥6000Cycle@80%DOD@0.5C Discharge Rate		
机械特性 Mechanical Characteristics	电芯类型 Battery Cell Type	方块电芯 Prismatic Battery Cell	
	电芯布局 Battery Cell Layout	16S	
	产品尺寸 Product Dimension	640*455*130mm	
	包装尺寸 Packing Dimension	750*570*280mm	
	净重量 Net Weight	45.1kg	
	毛重 Gross Weight	51.2kg	
	防护级别 Protection	Ip20	
	最大并联数 MAX Parallel	16PCS	
	工作温度 Working Temperature	0~45°C	
	储存温度 Storage Temperature	- 20~45°C	
电池端子 Power Terminal	M8组合螺丝紧固 M8 Combination screw fastening		
保护板特性 BMS Characteristics	最大放电电流 MAX Discharge Current	100A	
	最大充电电流 MAX Charging Current	100A	
	放电保护电压 Discharge Protection Voltage	43.2V	
	充电保护电压 Charge Protection Voltage	58.4V	
	浮充电压 Float Charge Voltage	57.6V	
	过流保护 Overcurrent Protection	130A	
	短路保护 Short-Circuit Protection	支持，断开负载后恢复 Supported, Recovery after the load disconnected	
	通讯接口 Communication Port	RS485/CAN	

# LiFePO<sub>4</sub> Battery

## 51.2V-10.24kWh-01/06

### 磷酸铁锂电池



## Features

### 产品亮点:

- 内置智能BMS保护模块  
Built in Intelligent BMS Protection Module.
- 循环寿命不低于6000次（使用条件80%放电深度，0.5C放电倍率）  
≥6000Cycle@80%DOD@0.5C Discharge Rate.
- 采用方形铝壳电芯，安全性能更高  
Adopting prismatic aluminum shell cells for higher safety performance.
- 采用模块化设计，可支持16台并联  
Adopting modular design, it can support 16 parallel devices.
- 两侧设有提手，方便搬运  
There are handles on both sides for easy transportation.
- 防护等级IP20，适合室内使用  
Protection level IP20, suitable for indoor use.
- 支持主流逆变器CAN&RS485通讯  
Support mainstream Inverter CAN&RS485 Communication.
- 通过LCD显示屏可进行本地监控  
Local Monitoring can be Achieved Through LCD Display Screen.

## Product Parameter

型号 Model		51.2V-10.24kWh-01	51.2V-10.24kWh-06
电学特性 Electrical Characteristics	电芯材料 Battery Cell Material	磷酸铁锂 Lithium Iron Phosphate (LiFePO <sub>4</sub> )	
	标称电压 Nominal Voltage	51.2V	
	标称容量 Nominal Capacity	200Ah	
	标称电量 Nominal Energy	10.24kWh	
	输出功率 Output Power	7.68kW	
	充电上限电压 Upper charge voltage:	55.2V	
	放电截止电压 Discharge cut-off voltage	44.8V	
	自放电率 Self-Discharge Rate	< 2%每月 < 2%Per Month	
寿命 Lifespan	≥6000Cycle@80%放电深度@0.5C放电倍率 ≥6000Cycle@80%DOD@0.5C Discharge Rate		
机械特性 Mechanical Characteristics	电芯类型 Battery Cell Type	方块电芯 Prismatic Battery Cell	
	电芯布局 Battery Cell Layout	16S	
	产品尺寸 Product Dimension	640*485*220mm	
	包装尺寸 Packing Dimension	745*560*375mm	
	净重量 Net Weight	85.15kg	
	毛重 Gross Weight	95.9kg	
	防护级别 Protection	Ip20	
	最大并联数 MAX Parallel	16PCS	
	工作温度 Working Temperature	0~55℃	
	储存温度 Storage Temperature	- 20~45℃	
电池端子 Power Terminal	M8组合螺丝紧固 M8 Combination screw fastening		
保护板特性 BMS Characteristics	最大放电电流 MAX Discharge Current	150A	
	最大充电电流 MAX Charging Current	150A	
	放电保护电压 Discharge Protection Voltage	43.2V	
	充电保护电压 Charge Protection Voltage	58.4V	
	浮充电压 Float Charge Voltage	57.6V	
	过流保护 Overcurrent Protection	180A	
	短路保护 Short-Circuit Protection	支持，断开负载后恢复 Supported, Recovery after the load disconnected	
	通讯接口 Communication Port	RS485/CAN	

# LiFePO<sub>4</sub> Battery 磷酸铁锂电池 51.2V-14.33kWh-01/06

壁挂51.2V-14.33kWh  
Wall mounted 51.2V-14.33kWh



## Features

### 产品亮点:

- 内置智能BMS保护模块  
Built in Intelligent BMS Protection Module.
- 循环寿命不低于6000次（使用条件80%放电深度，0.5C放电倍率）  
≥6000Cycle@80%DOD@0.5C Discharge Rate.
- 采用方形铝壳电芯，安全性能更高  
Adopting prismatic aluminum shell cells for higher safety performance.
- 采用模块化设计，可支持16台并联  
Adopting modular design, it can support 16 parallel devices.
- 两侧设有提手，方便搬运  
There are handles on both sides for easy transportation.
- 防护等级IP20，适合室内使用  
Protection level IP20, suitable for indoor use.
- 支持主流逆变器CAN&RS485通讯  
Support mainstream Inverter CAN&RS485 Communication.
- 通过LCD显示屏可进行本地监控  
Local Monitoring can be Achieved Through LCD Display Screen.

## Product Parameter

型号 Model		51.2V-14.33kWh-01	51.2V-14.33kWh-06	壁挂51.2V-14.33kWh Wall mounted 51.2V-14.33kWh	可移动51.2V-14.33kWh Portable 51.2V-14.33kWh
电学特性 Electrical Characteristics	电芯材料 Battery Cell Material	磷酸铁锂 Lithium Iron Phosphate (LiFePO <sub>4</sub> )			
	标称电压 Nominal Voltage	51.2V			
	标称容量 Nominal Capacity	280Ah			
	标称电量 Nominal Energy	14.33kWh			
	输出功率 Output Power	10.24 kW			
	充电上限电压 Upper charge voltage:	55.2V			
	放电截止电压 Discharge cut-off voltage	44.8V			
	自放电率 Self-Discharge Rate	< 3%每月 < 3%Per Month			
	寿命 Lifespan	≥6000Cycle@80%放电深度@0.5C放电倍率 ≥6000Cycle@80%DOD@0.5C Discharge Rate			
机械特性 Mechanical Characteristics	电芯类型 Battery Cell Type	方块电芯 Prismatic Battery Cell			
	电芯布局 Battery Cell Layout	16S			
	产品尺寸 Product Dimension	708*363*263mm	750*450*240mm	860*470*260mm	
	包装尺寸 Packing Dimension	825*470*410mm	835*515*440mm	945*535*400mm	
	净重量 Net Weight	108kg	113kg	117kg	
	毛重 Gross Weight	120kg	126kg	135kg	
	防护级别 Protection	Ip20			
	最大并联数 MAX Parallel	16PCS			
	工作温度 Working Temperature	0~55℃			
储存温度 Storage Temperature	- 20~45℃				
电池端子 Power Terminal	M8组合螺丝紧固 M8 Combination screw fastening				
保护板特性 BMS Characteristics	最大放电电流 MAX Discharge Current	200A			
	最大充电电流 MAX Charging Current	200A			
	放电保护电压 Discharge Protection Voltage	43.2V			
	充电保护电压 Charge Protection Voltage	58.4V			
	浮充电压 Float Charge Voltage	57.6V			
	过流保护 Overcurrent Protection	230A			
	短路保护 Short-Circuit Protection	支持，断开负载后恢复 Supported, Recovery after the load disconnected			
	通讯接口 Communication Port	RS485/CAN			

# Gel Battery 12V-100Ah

## 太阳能储能 胶体蓄电池



URAYZERO Solar gel storage battery 6-CNF-100

12V  
100Ah C<sub>20</sub>(1.8V/cell at 20°C)  
Nominal Float Voltage: 13.38~13.80V at 20°C  
Equalization Voltage: 14.60~14.80V at 20°C  
E<sub>max</sub>charge Current: 0.20C<sub>10</sub>A

Lei Ling Technology Co., LTD

### ● 电池规格 Specifications

额定电压	Nominal Voltage	12V
额定容量	Rated capacity (20HR)	100Ah
外形尺寸 Dimensions	长 Length	330±2mm(12.99inch)
	宽 Width	171±2mm(6.73inch)
	高 Height	214±2mm(8.43inch)
	总高 Total Height	220±2mm(8.66inch)
重量	Approx. Weight	27.3kg(60.18 lbs)±3%

### ● 外形尺寸 Outer dimensions (mm)

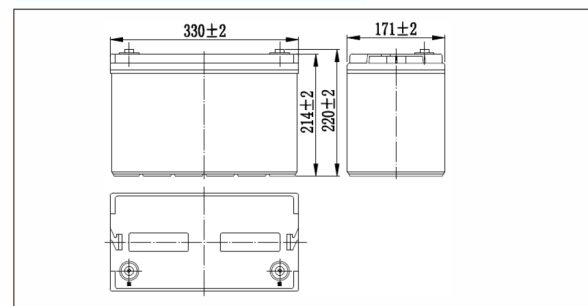

### ● 端子尺寸 Terminal Type (mm)

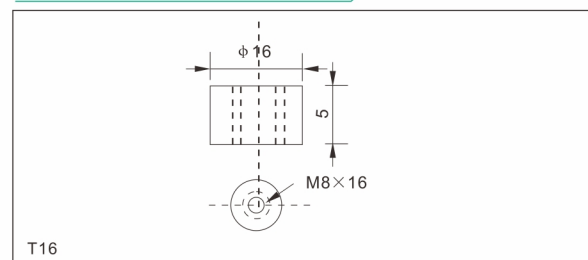

T16

### ● 电池特性 Characteristics

容量 Capacity (25°C)	20HR(10.8V)	100Ah
	3HR(10.8V)	75Ah
	1HR(10.5V)	55Ah
端子类型	Terminal type	T16
内阻 (安全充电, 25°C)	Internal resistance (Fully charged, 25°C)	约5mΩ Approx.5mΩ
温度对容量 的影响(20HR) Capacity affected by temperature (20HR)	40°C	102%
	25°C	100%
	0°C	85%
	-15°C	65%
自放电(25°C) Self-discharge (25°C)	3个月 3 months	剩余容量:91% Remaining Capacity:91%
	6个月 6 months	剩余容量:82% Remaining Capacity:82%
	12个月 12 months	剩余容量:65% Remaining Capacity:65%
标准 工作温度	Nominal operating temperature	25°C ± 3°C(77°F ± 5°F)
工作温度范围 Operating temperature range	放电 Discharge	-15°C~50°C(5°F~122°F)
	充电 Charge	-10°C~50°C(14°F~122°F)
	储能 Storage	-20°C~50°C(-4°F~122°F)
浮充电压(25°C) Float charging voltage(25°C)	13.50 to 13.80V 温度补偿: -18mV/C Temperature compensation: -18mV/C	
循环充电电压(25°C) Cyclic charging voltage(25°C)	14.40 to 14.70V 温度补偿: -30mV/C Temperature compensation: -30mV/C	
最大充电电流 Maximum charging current	20A	
最大放电电流 Maximum discharge current	700A(5 sec.)(5秒)	
设计浮充的寿命(20°C) Designed floating life(20°C)	12years (12年)	

### ● 电池结构 Construction

名称 Component	正极板 Positive plate	负极板 Negative plate	电槽 Container	电池盖 Cover	隔板 Separator	电解液 Electrolyte	安全阀 Safety valve	端子 Terminal
原材料 Raw material	二氧化铅 Lead dioxide	铅 Lead	ABS	ABS	AGM	胶体 Gel	橡胶 Rubber	铜 Copper

### ● 恒流放电特性: A(25°C, 77°F) Constant Current Discharge Characteristics Unit:A(25°C, 77°F)

终止电压/时间 F.V/Time	10min	15min	30min	60min	2h	3h	4h	5h	8h	10h	20h
9.60V	195	160	97.0	60.0	36.5	26.0	20.4	17.3	12.2	10.2	5.40
9.90V	189	156	95.1	59.1	36.3	25.9	20.3	17.2	12.2	10.2	5.38
10.2V	181	150	92.2	57.6	36.0	25.7	20.1	17.1	12.1	10.1	5.37
10.5V	174	145	89.9	55.8	35.5	25.5	20.0	17.0	12.0	10.1	5.34
10.8V	164	138	86.6	54.0	34.6	25.0	19.4	16.5	11.6	10.0	5.30

### ● 恒功率放电特性: W(25°C, 77°F) Constant Power Discharge Characteristics Unit:W(25°C, 77°F)

终止电压/时间 F.V/Time	10min	15min	30min	60min	2h	3h	4h	5h	8h	10h	20h
9.60V	2106	1757	1088	684	423	306	240	205	145	122	64.7
9.90V	2043	1715	1067	674	421	304	238	204	145	121	64.6
10.2V	1959	1651	1034	657	417	302	237	202	144	121	64.4
10.5V	1874	1595	1009	636	411	300	235	201	143	120	64.0
10.8V	1769	1511	972	616	400	294	228	195	138	119	63.6

备注: 以上放电数据可以在 3 次循环内达到。  
Note: The above characteristics data can be obtained within three charge or discharge cycles.

### ● 放电特性曲线(25°C) Discharge characteristics(25°C)

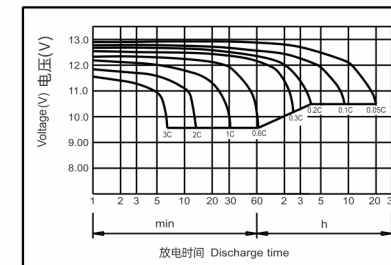

### ● 自放电特性曲线 Self-discharge characteristics

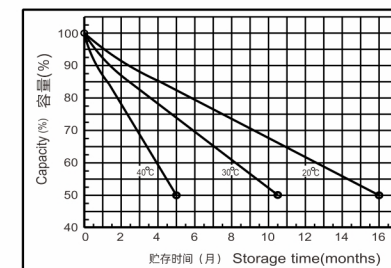

### ● 电池容量与开路电压对应关系曲线 The relationship for OCV and Capacity (25°C)

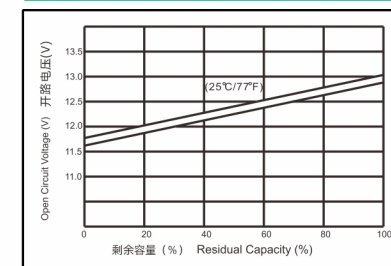

### ● 充电特性曲线(25°C) Charging characteristics (25°C)

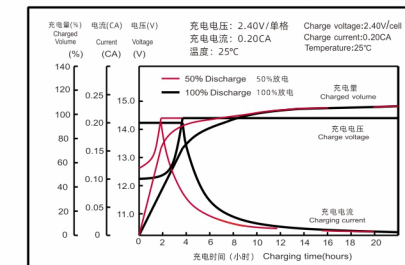

### ● 浮充寿命受温度影响特性曲线 Floating life on Temperature

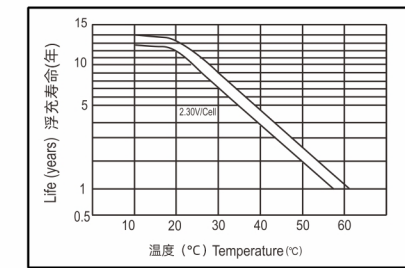

### ● 充电电压与温度对应关系曲线 The relationship for Charging voltage and Temperature

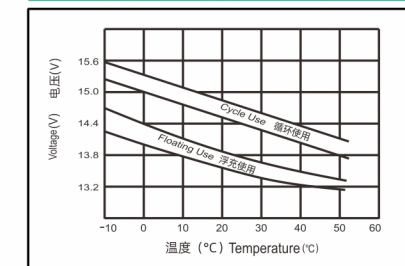

### ● 容量受温度影响特性曲线 Temperature effects on Capacity

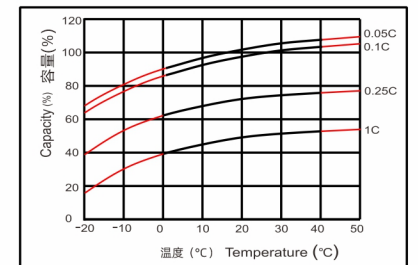

### ● 放电深度与循环寿命曲线(25°C) Cycle life on D.O.D (25°C)

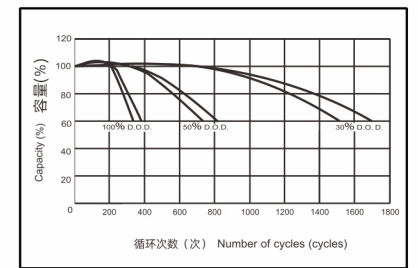

# Gel Battery 12V-200Ah

## 太阳能储能 胶体蓄电池



### ● 电池规格 Specifications

额定电压	Nominal Voltage	12V
额定容量	Rated capacity (20HR)	200Ah
外形尺寸 Dimensions	长 Length	522±2mm(20.55inch)
	宽 Width	238±2mm(9.37inch)
	高 Height	218±2mm(8.58inch)
	总高 Total Height	222±2mm(8.74inch)
重量	Approx. Weight	52.8kg(116.80lbs)±3%

### ● 外形尺寸 Outer dimensions (mm)

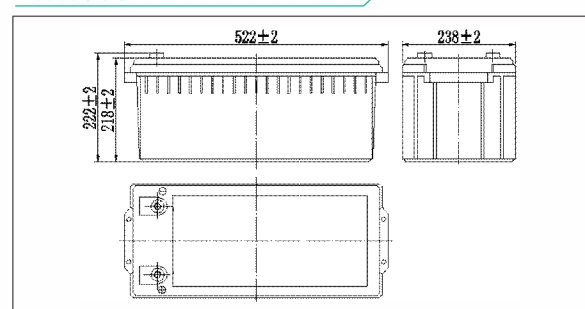

### ● 端子尺寸 Terminal Type (mm)

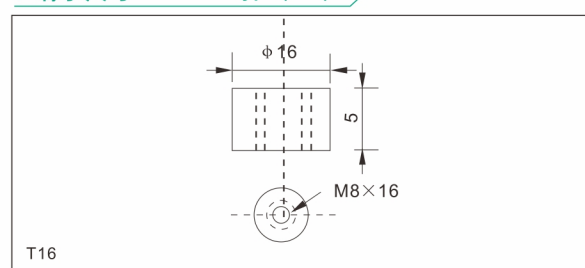

### ● 电池特性 Characteristics

容量 Capacity (25°C)	20HR(10.8V)	200Ah
	3HR(10.8V)	150Ah
	1HR(10.5V)	110Ah
端子类型	Terminal type	T16
内阻 (安全充电, 25°C)	Internal resistance (Fully charged, 25°C)	约 3.3mΩ Approx. 3.3mΩ
温度对容量 的影响(20HR) Capacity affected by temperature (20HR)	40°C	102%
	25°C	100%
	0°C	85%
自放电(25°C) Self-discharge (25°C)	3个月 months	剩余容量:91% Remaining Capacity:91%
	6个月 months	剩余容量:82% Remaining Capacity:82%
	12个月 months	剩余容量:65% Remaining Capacity:65%
标准 工作温度	Nominal operating temperature	25°C ±3°C(77°F ±5°F)
工作温度范围 Operating temperature range	放电 Discharge	-15°C~50°C(5°F~122°F)
	充电 Charge	-10°C~50°C(14°F~122°F)
	储能 Storage	-20°C~50°C(-4°F~122°F)
浮充电压(25°C) Float charging voltage(25°C)	13.50 to 13.80V 温度补偿: -18mV/°C Temperature compensation: -18mV/°C	
循环充电电压(25°C) Cyclic charging voltage(25°C)	14.40 to 14.70V 温度补偿: -30mV/°C Temperature compensation: -30mV/°C	
最大充电电流 Maximum charging current	40A	
最大放电电流 Maximum discharge current	1400A(5 sec.)(5秒)	
设计浮充的寿命(20°C) Designed floating life(20°C)	12years (12年)	

### ● 电池结构 Construction

名称 Component	正极板 Positive plate	负极板 Negative plate	电槽 Container	电池盖 Cover	隔板 Separator	电解液 Electrolyte	安全阀 Safety valve	端子 Terminal
原材质 Raw material	二氧化铅 Lead dioxide	铅 Lead	ABS	ABS	AGM	胶体 Gel	橡胶 Rubber	铜 Copper

### ● 恒流放电特性: A(25°C,77°F) Constant Current Discharge Characteristics Unit:A(25°C,77°F)

终止电压/时间 F.V/Time	15min	30min	60min	2h	3h	4h	5h	6h	8h	10h	20h
9.60V	320	194	120	73.1	52.0	40.8	34.7	30.6	24.5	20.4	10.8
9.90V	312	190	118	72.6	51.7	40.6	34.5	30.4	24.3	20.3	10.8
10.2V	301	184	115	72.0	51.4	40.3	34.2	30.2	24.2	20.3	10.7
10.5V	291	180	112	70.9	51.0	40.0	34.0	30.0	24.0	20.1	10.7
10.8V	275	173	108	69.1	50.0	38.8	33.0	29.1	23.3	20.0	10.6

### ● 恒功率放电特性: W(25°C,77°F) Constant Power Discharge Characteristics Unit:W(25°C,77°F)

终止电压/时间 F.V/Time	15min	30min	60min	2h	3h	4h	5h	6h	8h	10h	20h
9.60V	3514	2177	1368	846	612	480	410	362	291	243	129
9.90V	3429	2133	1347	841	608	477	408	360	289	243	129
10.2V	3303	2068	1313	834	604	474	405	357	287	242	129
10.5V	3190	2018	1272	821	600	470	402	355	285	240	128
10.8V	3022	1944	1231	800	588	456	390	344	277	239	127

备注: 以上放电数据可以在 3 次循环内达到。  
Note: The above characteristics data can be obtained within three charge or discharge cycles.

### ● 放电特性曲线(25°C) Discharge characteristics(25°C)

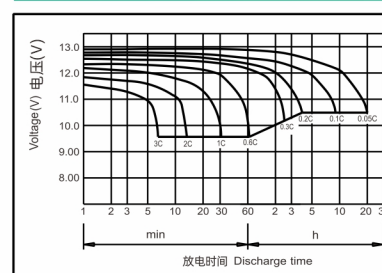

### ● 充电特性曲线(25°C) Charging characteristics(25°C)

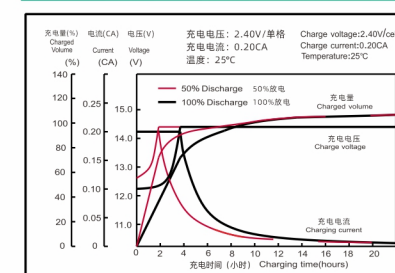

### ● 容量受温度影响特性曲线 Temperature effects on Capacity

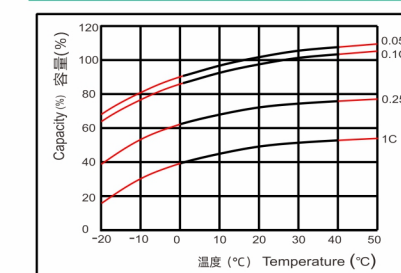

### ● 自放电特性曲线 Self-discharge characteristics

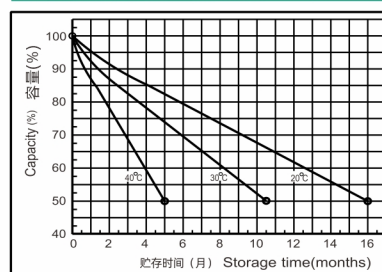

### ● 浮充寿命受温度影响特性曲线 Floating life on Temperature

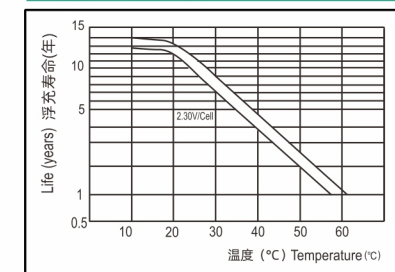

### ● 放电深度与循环寿命曲线(25°C) Cycle life on D.O.D.(25°C)

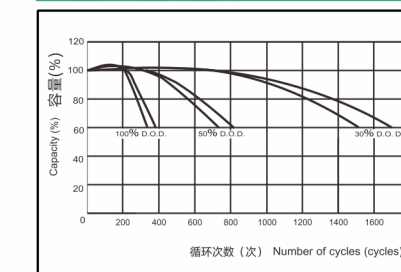

### ● 电池容量与开路电压对应关系曲线 The relationship for OCV and Capacity(25°C)

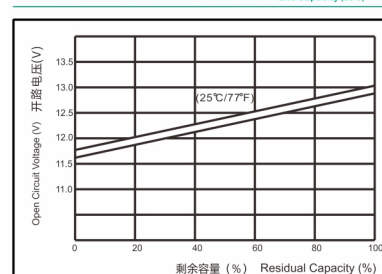

### ● 充电电压与温度对应关系曲线 The relationship for Charging voltage and Temperature

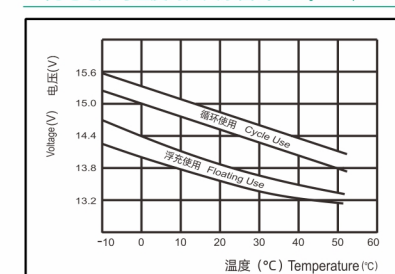

# Gel Battery

## 12V-250Ah

### 太阳能储能胶体蓄电池



#### ● 电池规格 Specifications

额定电压	Nominal Voltage	12V
额定容量	Rated capacity (20HR)	250Ah
外形尺寸 Dimensions	长 Length	521±2mm(20.51inch)
	宽 Width	269±2mm(10.59inch)
	高 Height	220±2mm(8.66inch)
	总高 Total Height	224±2mm(8.82inch)
重量	Approx. Weight	66.8kg (147.26lbs)±3%

#### ● 外形尺寸 Outer dimensions (mm)

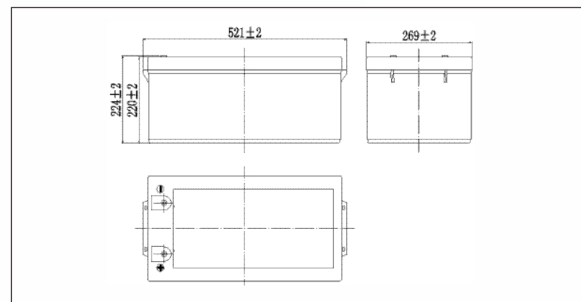

#### ● 端子尺寸 Terminal Type (mm)

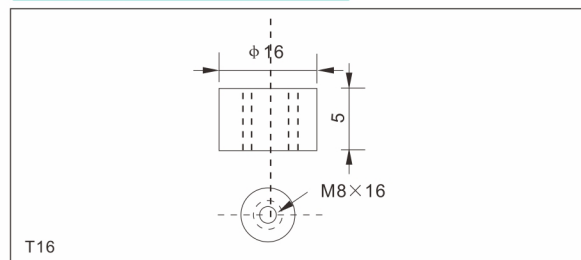

#### ● 电池特性 Characteristics

容量 Capacity (25°C)	20HR(10.8V)	250Ah
	3HR(10.8V)	187Ah
	1HR(10.5V)	137Ah
端子类型	Terminal type	T16
内阻 (安全充电, 25°C)	Internal resistance (Fully charged, 25°C)	约2.8m Ω Approx. 2.8m Ω
温度对容量 的影响(20HR) Capacity affected by temperature (20HR)	40°C	102%
	25°C	100%
	0°C	85%
	-15°C	65%
自放电 (25°C) Self-discharge (25°C)	3个月 3 months	剩余容量:91% Remaining Capacity:91%
	6个月 6 months	剩余容量:82% Remaining Capacity:82%
	12个月 12 months	剩余容量:65% Remaining Capacity:65%
标准 工作温度	Nominal operating temperature	25°C ± 3°C (77°F ± 5°F)
工作温度范围 Operating temperature range	放电 Discharge	-15°C~50°C (5°F~122°F)
	充电 Charge	-10°C~50°C (14°F~122°F)
	储能 Storage	-20°C~50°C (-4°F~122°F)
浮充电压(25°C) Float charging voltage(25°C)	13.50 to 13.80V 温度补偿: -18mV/°C Temperature compensation: -18mV/°C	
循环充电电压(25°C) Cyclic charging voltage(25°C)	14.40 to 14.70V 温度补偿: -30mV/°C Temperature compensation: -30mV/°C	
最大充电电流 Maximum charging current	50A	
最大放电电流 Maximum discharge current	1500A(5 sec.) (5秒)	
设计浮充的寿命(20°C) Designed floating life(20°C)	12years (12年)	

#### ● 电池结构 Construction

名称 Component	正极板 Positive plate	负极板 Negative plate	电槽 Container	电池盖 Cover	隔板 Separator	电解液 Electrolyte	安全阀 Safety valve	端子 Terminal
原材料 Raw material	二氧化铅 Lead dioxide	铅 Lead	ABS	ABS	AGM	胶体 Gel	橡胶 Rubber	铜 Copper

#### ● 恒流放电特性: A(25°C, 77°F) Constant Current Discharge Characteristics Unit:A(25°C, 77°F)

终止电压/时间 F.V/Time	15min	30min	60min	2h	3h	4h	5h	6h	8h	10h	20h
9.60V	400	243	150	91.4	65.0	51.0	43.4	38.3	30.6	25.5	13.5
9.90V	390	238	148	90.8	64.6	50.7	43.1	38.0	30.4	25.4	13.5
10.2V	376	230	144	90.0	64.2	50.4	42.8	37.8	30.2	25.3	13.4
10.5V	363	225	140	88.7	63.8	50.0	42.5	37.5	30.0	25.2	13.3
10.8V	344	217	135	86.4	62.5	48.5	41.2	36.4	29.1	25.0	13.3

#### ● 恒功率放电特性: W(25°C, 77°F) Constant Power Discharge Characteristics Unit:W(25°C, 77°F)

终止电压/时间 F.V/Time	15min	30min	60min	2h	3h	4h	5h	6h	8h	10h	20h
9.60V	4392	2721	1710	1058	765	600	512	452	364	304	162
9.90V	4287	2666	1684	1052	760	596	509	449	361	303	162
10.2V	4128	2585	1642	1042	755	592	506	446	359	302	161
10.5V	3988	2522	1590	1027	750	588	502	443	356	301	160
10.8V	3777	2430	1539	1001	735	570	487	430	346	299	159

备注: 以上放电数据可以在3次循环内达到。

Note: The above characteristics data can be obtained within three charge or discharge cycles.

#### ● 放电特性曲线(25°C) Discharge characteristics(25°C)

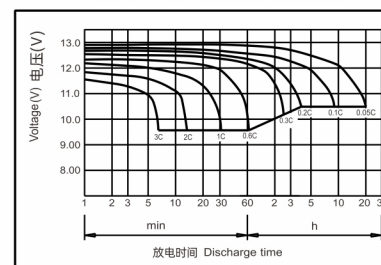

#### ● 充电特性曲线(25°C) Charging characteristics(25°C)

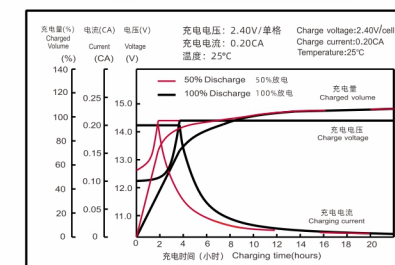

#### ● 容量受温度影响特性曲线 Temperature effects on Capacity

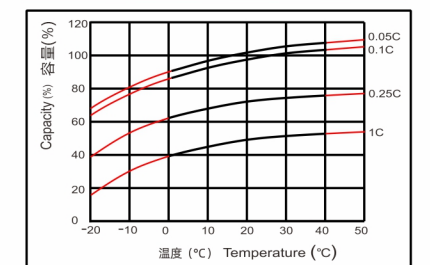

#### ● 自放电特性曲线 Self-discharge characteristics

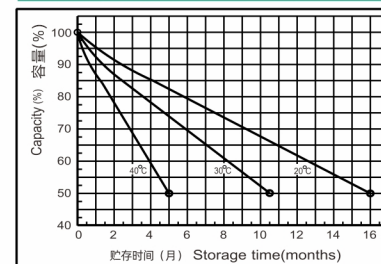

#### ● 浮充寿命受温度影响特性曲线 Floating life on Temperature

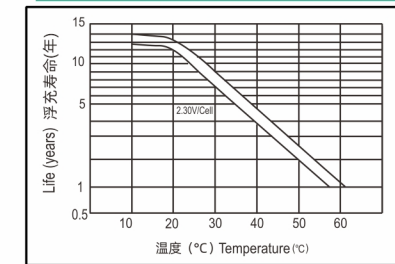

#### ● 放电深度与循环寿命曲线(25°C) Cycle life on D.O.D.(25°C)

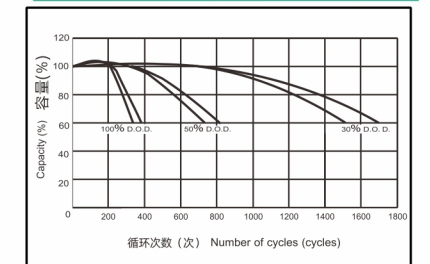

#### ● 电池容量与开路电压对应关系曲线 The relationship for OCV and Capacity (25°C)

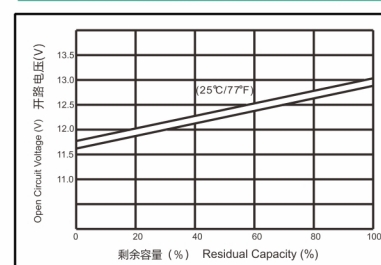

#### ● 充电电压与温度对应关系曲线 The relationship for Charging voltage and Temperature

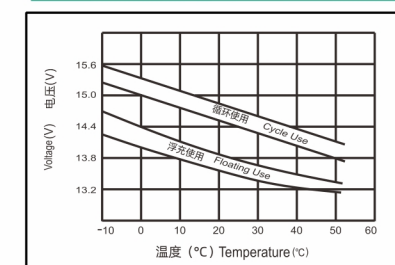

# ZQDY-24V280Ah 驻启一体锂电池



## Features

### 产品亮点:

- 内置智能BMS保护模块  
Built in Intelligent BMS Protection Module
- 循环寿命不低于4000次（使用条件80%放电深度，0.5C放电倍率）  
≥4000Cycle@80%DOD@0.5C Discharge Rate
- 采用方形铝壳电芯，安全性能更高  
Adopting prismatic aluminum shell cells for higher safety performance
- 两侧设有提手，方便搬运  
There are handles on both sides for easy transportation
- 防护等级IP50，适合户外干燥使用  
Protection level IP50, Suitable for outdoor dry use
- 支持强启功能、自动加热、充放保护、自动均衡  
Support Forced Start, Automatic Heating, Charging and Discharging Protection, and Automatic Balancing
- 支持蓝牙，通过手机连接  
Supports Bluetooth, Connected Through Mobile Phone

型号 Model	ZQDY-24V280Ah
电芯材料 Battery Cell Material	磷酸铁锂 Lithium Iron Phosphate (LiFePO <sub>4</sub> )
标称电压 Nominal Voltage	25.6V
标称容量 Nominal Capacity	280Ah
标称电量 Nominal Energy	7.17kWh
输出功率 Output Power	5.12kW
充电上限电压 Upper charge voltage:	27.6V
放电截止电压 Discharge cut-off voltage	22.4V
自放电率 Self-Discharge Rate	< 2%每月 < 2%Per Month
寿命 Lifespan	≥4000Cycle@80%放电深度@0.5C放电倍率 ≥4000Cycle@80%DOD@0.5C Discharge Rate
电芯类型 Battery Cell Type	方块电芯 Prismatic Battery Cell
电芯布局 Battery Cell Layout	8S
产品尺寸 Product Dimension	537*402*215mm
包装尺寸 Packing Dimension	577*442*385mm
净重量 Net Weight	57.7kg
毛重 Gross Weight	66.25kg
防护级别 Protection	IP50
工作温度 Working Temperature	-20~45°C
储存温度 Storage Temperature	-20~45°C
电池端子 Power Terminal	M8组合螺丝紧固 M8 Combination screw fastening
最大放电电流 MAX Discharge Current	200A
最大充电电流 MAX Charging Current	200A
放电保护电压 Discharge Protection Voltage	43.2V
充电保护电压 Charge Protection Voltage	29.2V
浮充电压 Float Charge Voltage	28.8V
过流保护 Overcurrent Protection	230A
短路保护 Short-Circuit Protection	支持，断开负载后恢复 Supported, Recovery after the load disconnected
通讯方式 Communication Method	蓝牙 Bluetooth